

03 9794 0415  
[sunriseint.com.au/wolf/](http://sunriseint.com.au/wolf/)

## STEP 1 CHOOSE YOUR MODEL

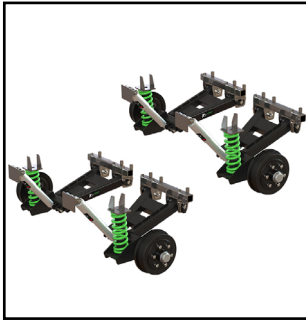

WIS2.8TT  
2800KG Rating Tandem

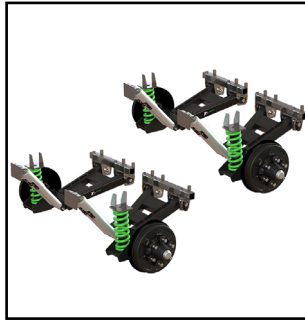

WIS4.0TT  
4000KG Rating Tandem

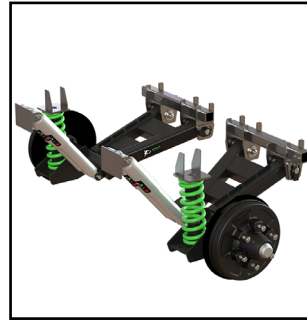

WIS2.2TS  
2200KG Rating Single

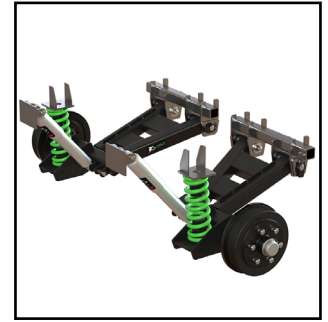

WIS1.6TS  
1600KG Rating Single

## STEP 2 CHOOSE YOUR COLOUR



Wolf Classic

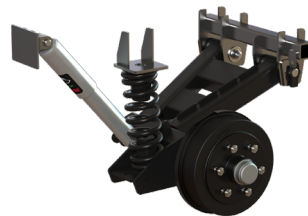

Carbon Black



KYB Red



Sunrise Orange



Wolf Green



Marine Blue

## STEP 3 CHOOSE YOUR BRAKE TYPE



Electric Drum Brake OFF-ROAD

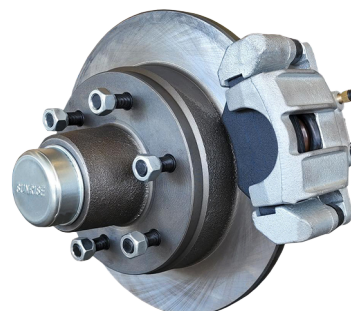

Hydraulic Disc Brake



## STEP 4 CHOOSE YOUR STUD PATTERN

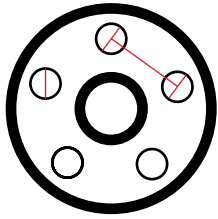

Landcruiser 5 Stud

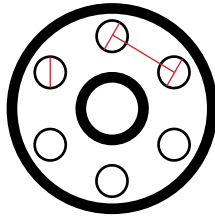

Landcruiser 6 Stud

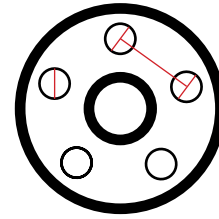

Ford 5 Stud  
(Only 10" Brakes)

Stud Pattern	Stud PCD	Stud Distance	Common Stud Size
Landcruiser 5 Stud	5 x 150mm	88.20mm	9/16"
Landcruiser 6 Stud	6 x 139.7mm	69.85mm	1/2"
Ford 5 Stud	5 x 114.3mm	67.18mm	1/2"

## STEP 5 TELL US YOUR WHEEL OFFSET

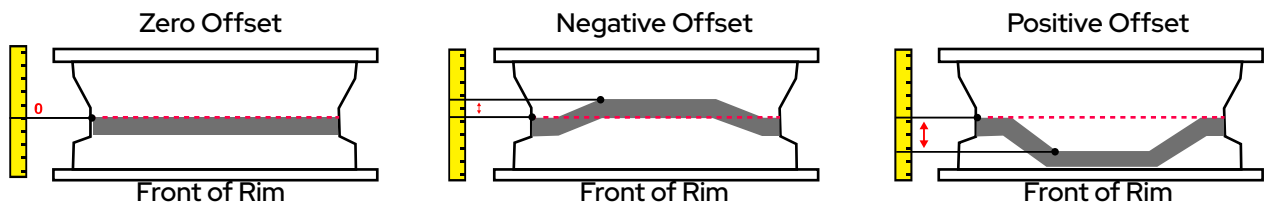

**There are three common types of wheel offset you may encounter:**

Place the straight edge across the back of the wheel so that it spans the entire width.

Measure from the mounting surface to the centerline of the wheel. If the mounting surface is towards the outside (front) of the wheel, it's positive offset. If it's towards the inside (back), it's negative offset.

The measurement is typically in millimeters.

## STEP 6 TELL US YOUR CLEARANCE REQUIRED

The recommended clearance for chassis to tire distance is 50mm, measured from the outer wall of the chassis to the edge of the tire.

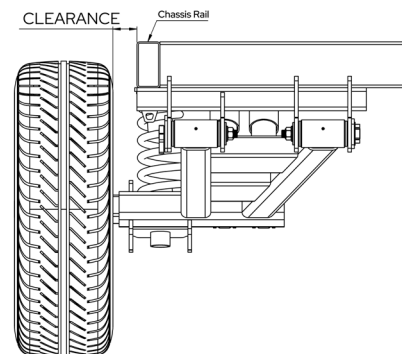

# ORDER FORM

Code	WIS1.6TS	WIS2.8TT	WIS2.0TS	WIS4.0TT
Stub Profile	Parallel	Parallel	2T	2T
ATM (Aggregate Trailer Mass) Rating	1.6T - Single	2.8T - Tandem	2.2T - Single	4.0T - Tandem
Brakes (Electric or Hydraulic)				
Stud Pattern (L/C 5, L/C 6, Ford 5)				
Wheel Offset and Tyre Width				
KYB TENAFORCE Shock Absorbers	Single - 1 Pair	Single - 1 Pair	Twin - 2 Pairs	Twin - 2 Pairs
Suspension Colours				
Clearance				
QTY				

Other:

To Be Filled By Customer		For Order Only	
Quote	Order	Purchase Order#	
		Delivery	Pick Up
Name:		Requested Due Date:	
Company:		Any Other Requests or Information:	
Address:			
Phone:			
Email:			

[SUBMIT](#)

Email all orders to [sales@sunriseint.com.au](mailto:sales@sunriseint.com.au) or to your respective branch sales representative

